



# WALL-HUNG VANITY WITH UNDERMOUNT SINK

## BEFORE YOU BEGIN

We recommend consulting a professional if you are unfamiliar with installing bathroom fixtures and plumbing. Signature Hardware accepts no liability for any damage to the floor, walls, plumbing, vanity cabinet, sink, counter top, or personal injury during installation.

Observe all local plumbing and building codes.

Unpack and inspect the vanity for damage. If any damage is found, contact our Customer Relations team at 1-866-855-2284.

## GETTING STARTED

- Ensure that you have gathered all the required materials that are needed for the installation.
- Ensure that your bathroom floor is adequately supported, and the finished floor is level.
- Ensure that there is adequate support behind the bathroom wall before installation.

## PLANNING

Use the vanity's PDF specification sheet as a reference when planning your layout. The specification sheet can be found and downloaded from the product page on our website.

Because the vanity specification measurements are approximate and slight variations may occur, we highly recommend performing any rough-in procedures with the vanity on site.

## TOOLS AND MATERIALS:

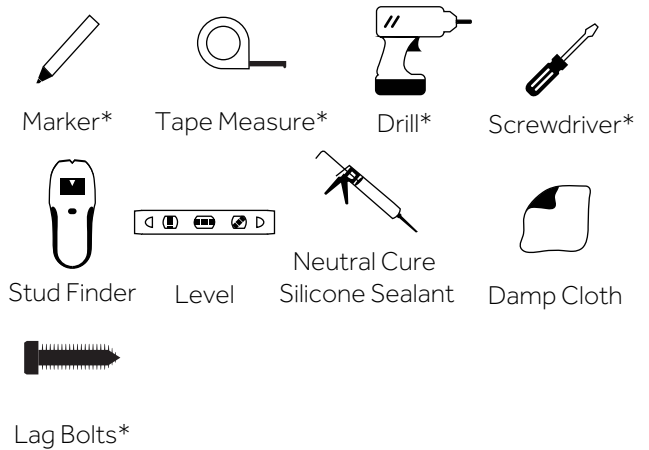

\*not included

NEVER LIFT THE VANITY TOP FLAT



NEVER CARRY THE VANITY TOP FLAT

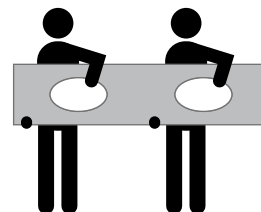
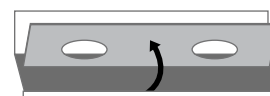
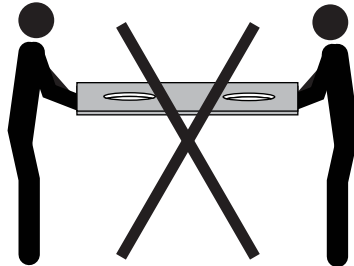



# WALL-HUNG VANITY WITH UNDERMOUNT SINK

## INSTALLATION

### STEP 1: CABINET INSTALLATION

1. Determine the location where you would like to install your vanity.

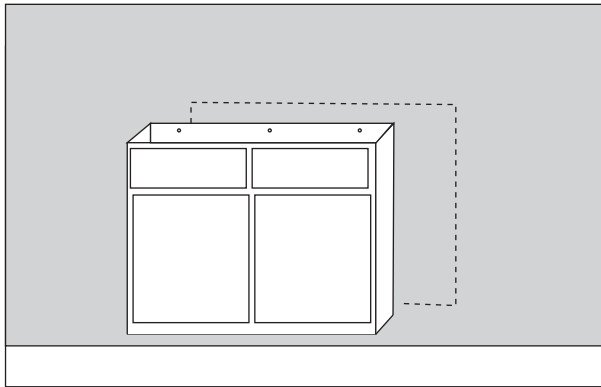

2. With the assistance of others, hold the vanity against the wall in its mounting location. Maneuver the vanity until it is level. Once positioned, mark the location of each of the vanity's mounting holes on your bathroom wall.

**Important:** If the studs in your bathroom do not line up to the mounting location for your vanity, wood blocking can be installed between the studs using standard 2 x 4's. If the wood blocking needs to be installed behind the finished wall, we recommend consulting a professional if you are unfamiliar with this type of installation.

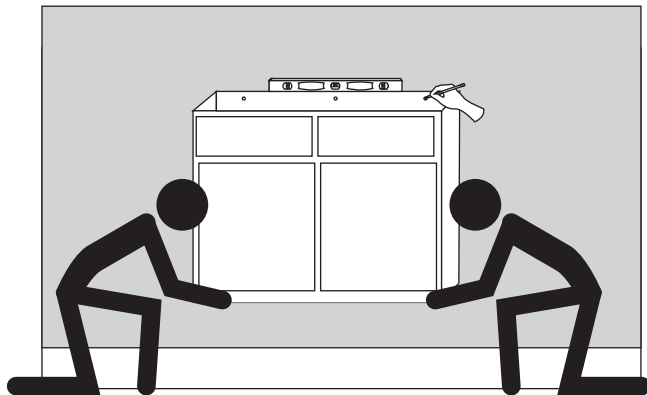

3. Set the vanity aside, and drill pilot holes into the marked mounting locations on your wall.

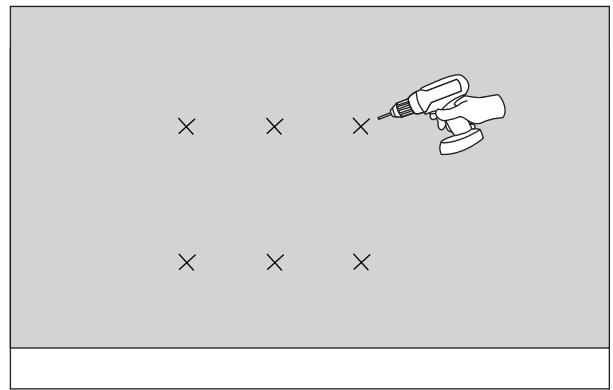

4. With the assistance of others, hold the vanity against the wall and line it up with the pilot holes drilled in step 3. Secure the vanity to the wall using lag bolts.

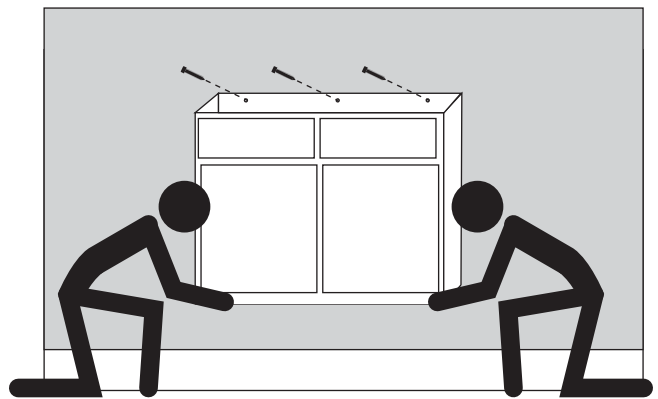



# WALL-HUNG VANITY WITH UNDERMOUNT SINK

## Step 2: Sink Installation

1. Carefully turn the counter top over, resting it on a soft, stable surface to prevent damage.

**Important:** The counter top is very fragile. Take caution when handling, and have someone assist you.

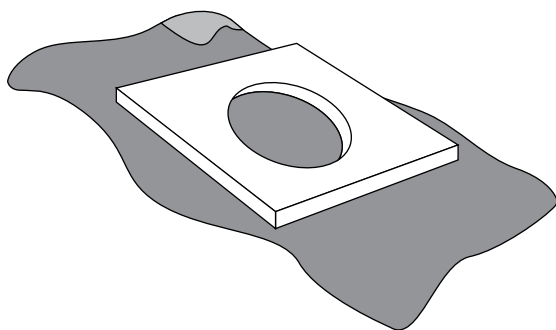

2. Position the sink over its cutout on the counter top. Make sure the sink is centered with the faucet hole and is evenly spaced between the bolt holes.

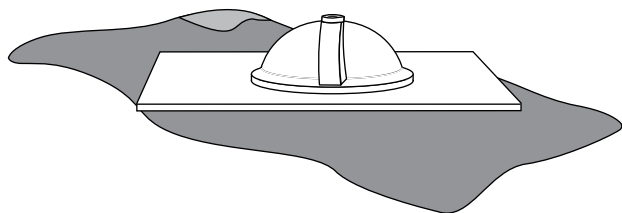

3. Use a pencil or marker to draw an outline around the sink perimeter.

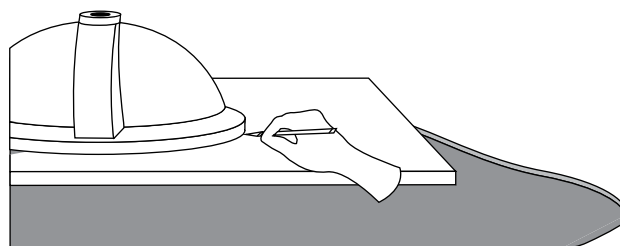

4. Remove the sink from the counter top. Apply a bead of silicone sealant around the top edge of the sink rim.

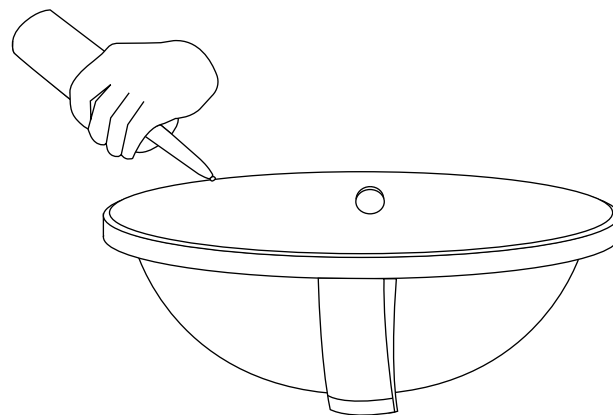



# WALL-HUNG VANITY WITH UNDERMOUNT SINK

5. Carefully place the sink upside down on the counter top, positioning it within your marked outline. Once positioned, press firmly into place.

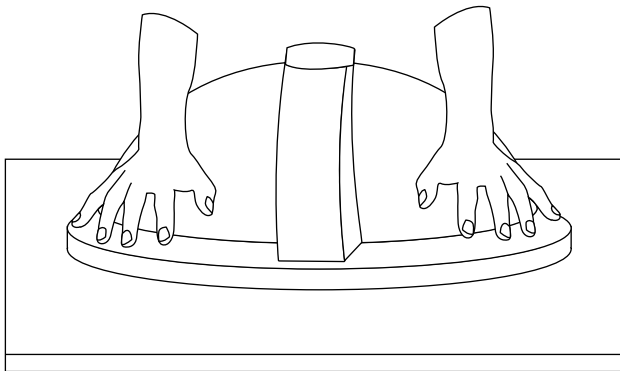

6. At each of the bolt holes in the counter top, attach sink clips by placing the long end of the bracket flat against the sink lip. Screw the wing bolts through the brackets and bolt holes and tighten.

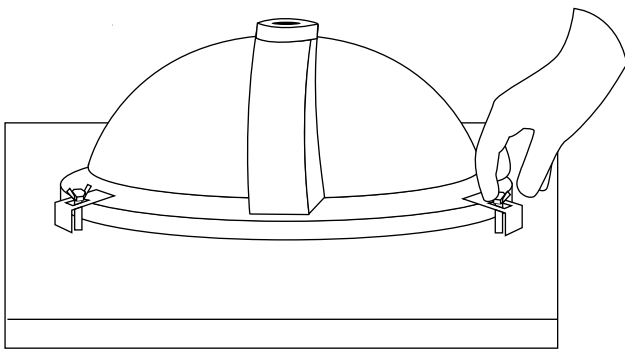

7. If you are installing a double sink vanity, repeat steps 2-6 for installing the second sink.

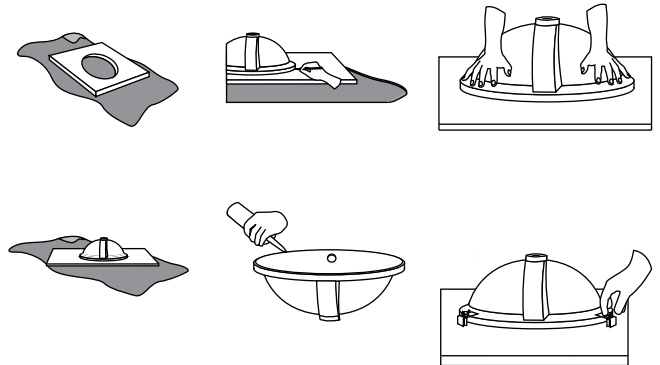

8. Carefully turn the counter top and sinks over. If needed, reposition the sinks by slightly loosening the wing bolts and adjusting.

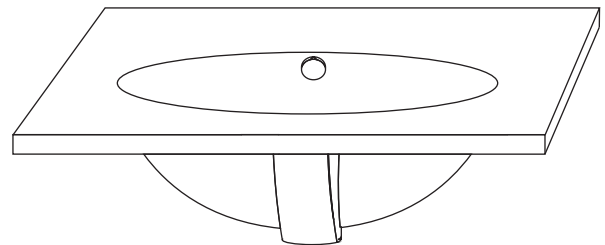

9. Wipe away any excess sealant with a damp cloth, and allow the sealant to dry. Once the sealant is dry, proceed to Step 3.

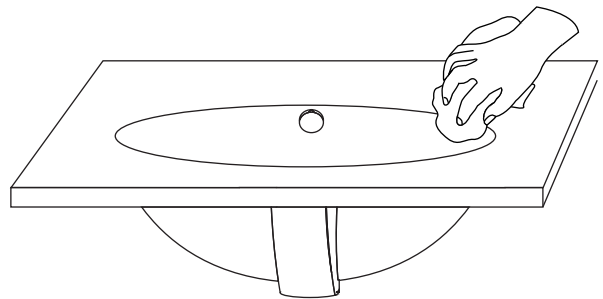



# WALL-HUNG VANITY WITH UNDERMOUNT SINK

## STEP 3: COUNTER TOP INSTALLATION

1. Apply a bead of silicone sealant around the top edge of the vanity cabinet.

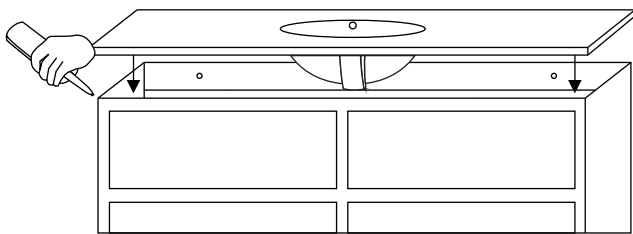

2. With assistance from another person, slowly and carefully set the counter top onto the vanity cabinet. Once positioned, press firmly into place. Wipe away an excess sealant using a damp cloth.

**Important:** The sink is fragile. Take caution when handling, and have someone assist if needed.

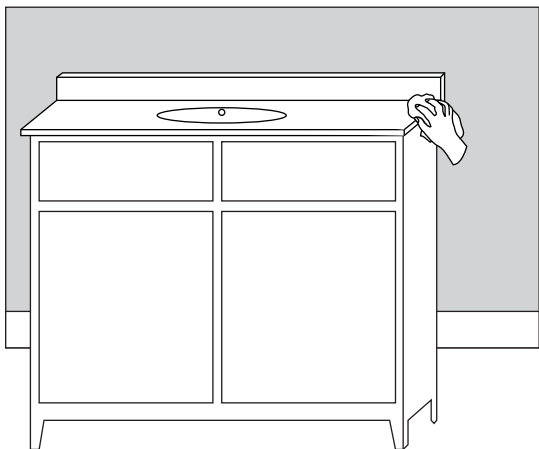

3. If you are installing a side-splash and/or back-splash, place a generous amount of silicone sealant on the back of it and press it into place against your bathroom wall. Fill any gaps that are left with silicone sealant. Wipe away an excess sealant with a damp cloth.

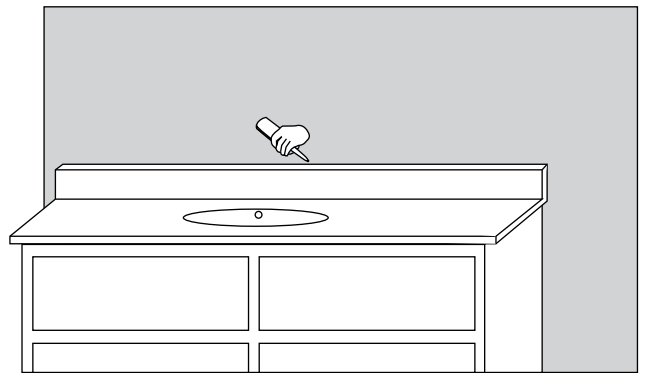

4. Let the assembled vanity sit for 24 hours to allow all the silicone sealant to fully dry. Once dry, proceed to the installation of your faucet and drain.

**Note:** In some situations, it may be necessary to cut the inner cabinet shelf to allow space for your drain's P-trap.



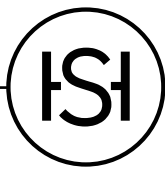

## WALL-HUNG VANITY WITH UNDERMOUNT SINK

6. For stone tops, such as marble and granite, it is recommended that you apply a high-quality sealer to protect from staining and discoloration. Stone sealer should be reapplied once or twice per year, depending upon usage.

