

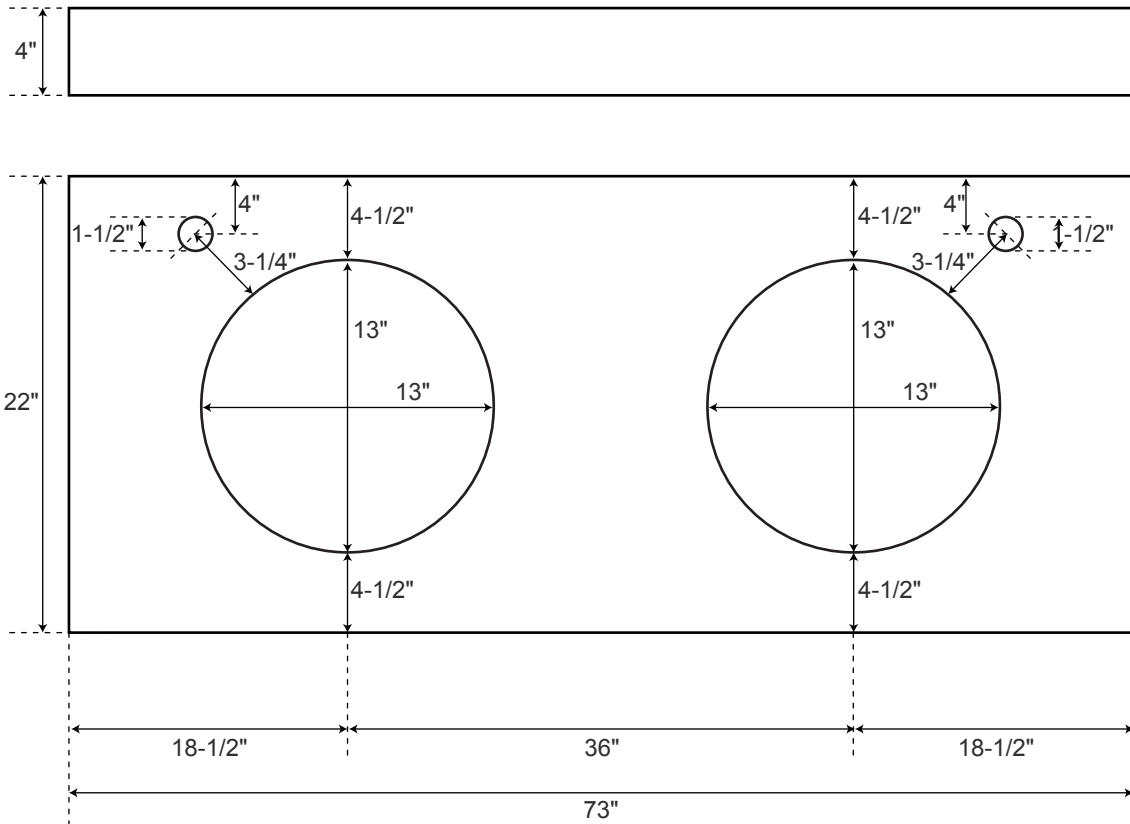

73" Stone

Vanity Top for
Semi-Recessed Sinks



Approximate Weights

Granite	190 – 210 lbs.
Marble	180 – 195 lbs.
Quartz	175 – 185 lbs.

* Measurements are approximate. It is recommended to have the product at the job site before finalizing plumbing.



SPECIFICATIONS

Overall Dimensions	17-1/8" diameter x 6" H
Basin Dimensions	14-1/2" diameter
Above Counter Height	3-1/2"
Water Depth	2-3/8" to overflow
Drain Hole	1-1/2" diameter

Optional
Porcelain
Semi-Recessed Sink

All measurements are approximate

Top

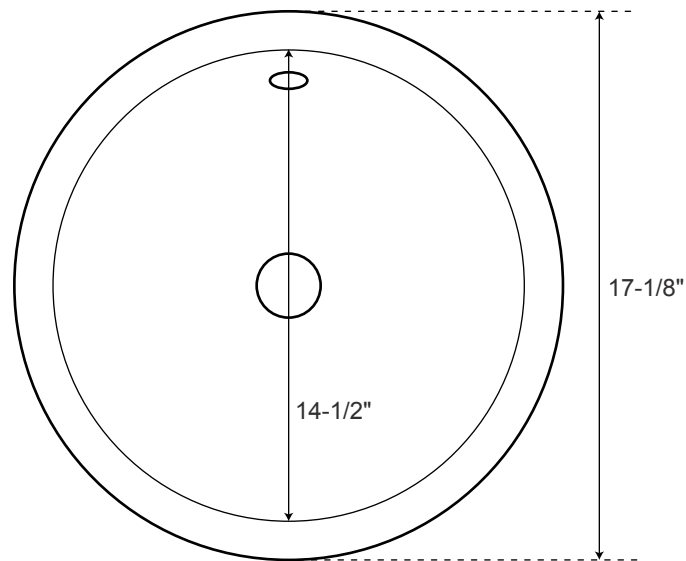

Front





SPECIFICATIONS

Overall Dimensions	17" diameter x 6-5/8" H
Basin Dimensions	14-3/4" diameter
Above Counter Height	3-1/2"
Water Depth	6-1/4" to rim
Drain Hole	1-1/2" diameter

Optional
Copper
Semi-Recessed Sink

All measurements are approximate

Top

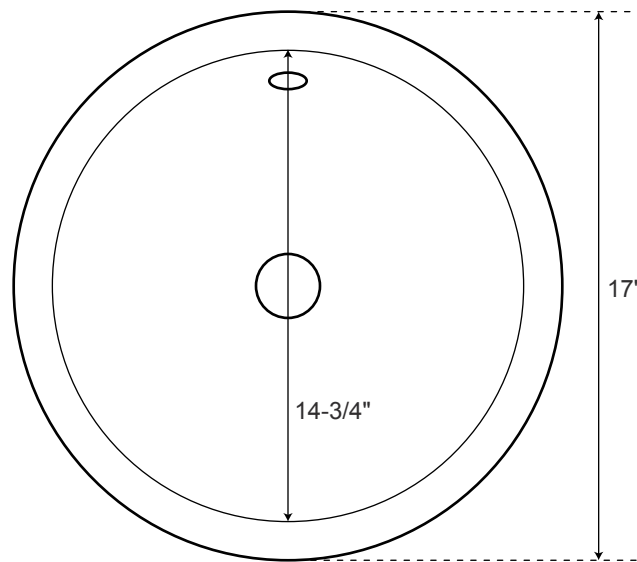

Front

